

B2

Dispense Options



Chilled



Ambient



Hot

Contents

Component/Feature Overview

Operation

Functions & Controls

Basic Troubleshooting

General Safety

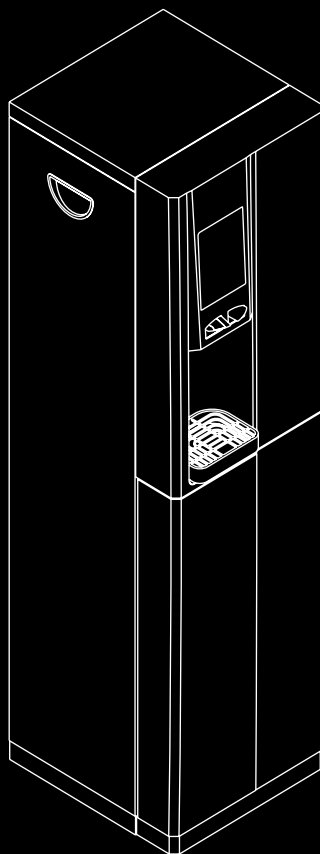

General Safety

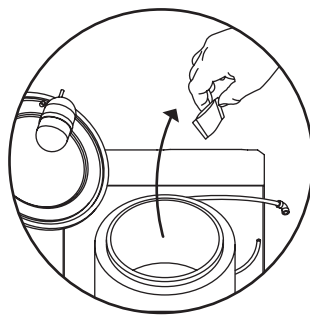

WARNING: On reservoir models the Carbon bag must be removed from the cold tank before connecting to power and water.

- Leave a space no less than 1.5cm between the wall and dispenser.
- Keep the machine away from sunlight, heat and moisture.

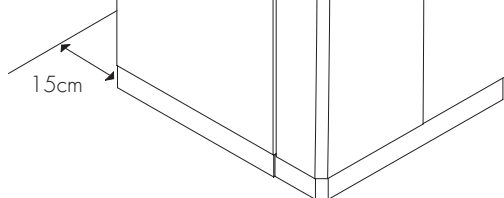

Component/ Feature Overview

B2 - Major Components

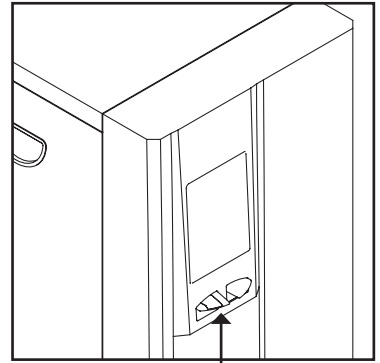
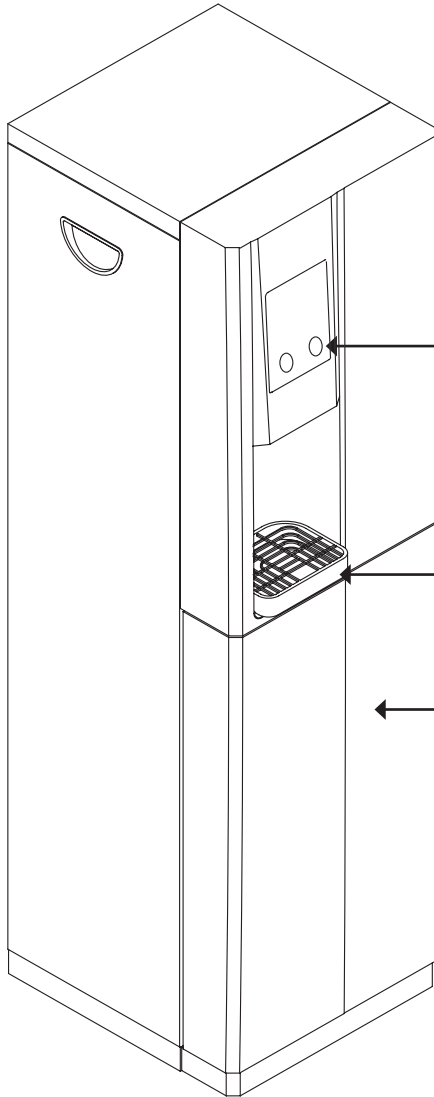

Dispense Taps

Dispense Buttons

Drip Tray

Door



Level Sensor
Alarm

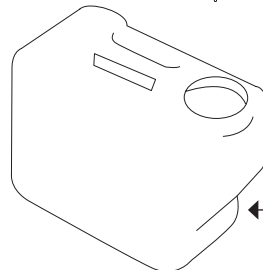

Waste Tank

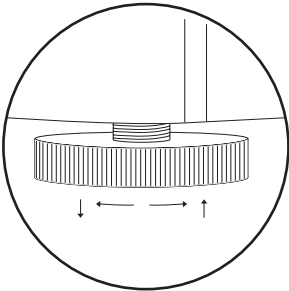
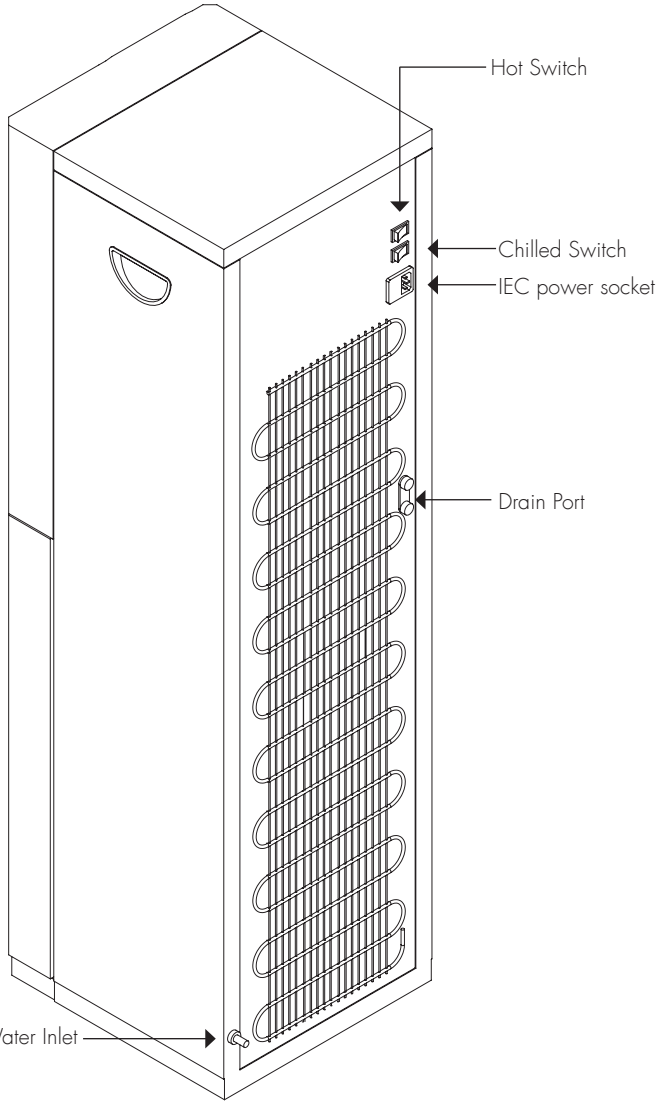

Operation

WARNING: On reservoir models the Carbon bag must be removed from the cold tank before connecting to power and water.

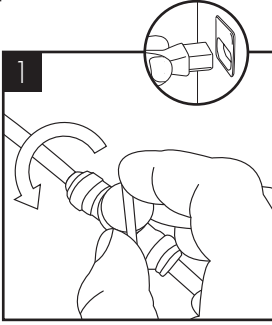

Connect and turn on the water supply. Then connect the power supply.

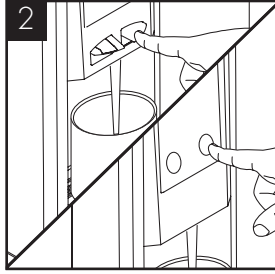

Dispense from all options (to confirm water supply).

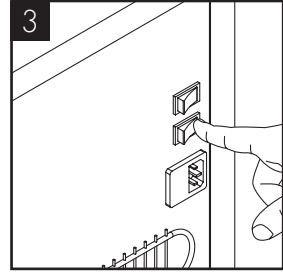

Turn on the cold switch (located at the rear on the unit) to begin the chilling process.

Turn on the hot switch (also located at the rear on the unit) to activate the heating element.

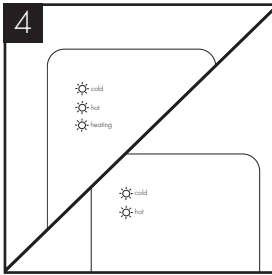

The relevant indicator lights will be lit.

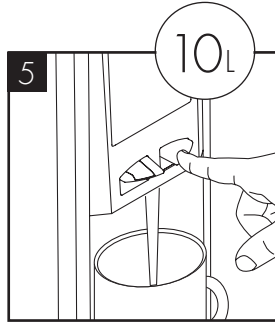

Flush through 10 litres of water before use.

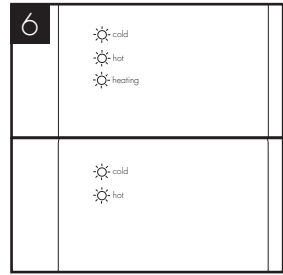

Chilled & Ambient:

When the Green LED is on the cooling circuit is activated.

When the Yellow LED is on the compressor is operating.

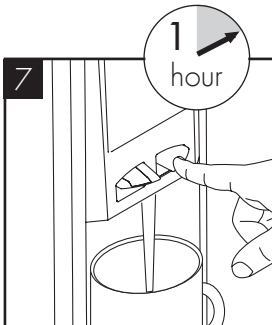

Allow up to 1 hour for the water to reach its minimum temperature.

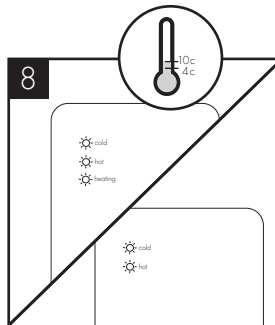

The temperature of the chilled water can be set from 4c to 10c. When the chilling LED is off the set temperature has been reached. This can take up to one hour.

Chilled & Hot:

When the Green LED is on the cooling circuit is activated.

When the Yellow LED is on heating circuit is activated.

When the Red LED is on the heating element is activated.

Functions & Controls

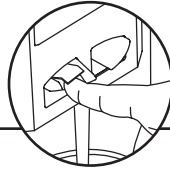

Hot Models: Lift hot water lock button prior to dispense

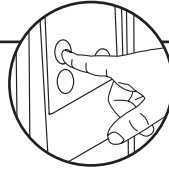
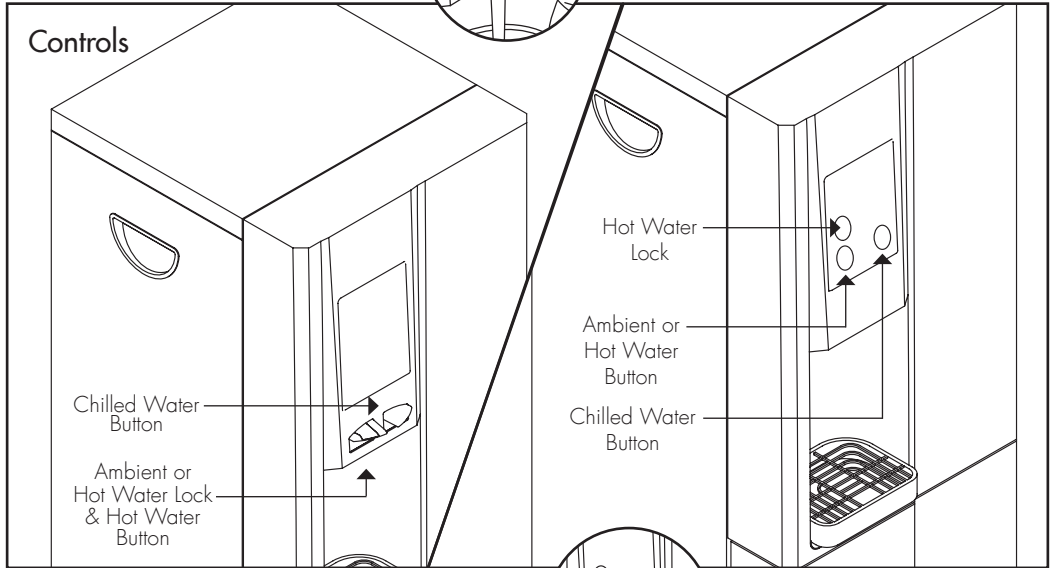

Hot Models: Press hot water lock button and then hot water button to dispense.

Basic Settings

Cold Thermostat

Factory set to:

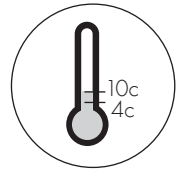
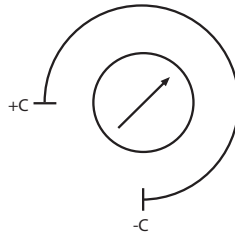

NB: Turn clockwise to decrease water temperature
The temperature of cold water can be set from 4c to 10c.

Basic Troubleshooting

Problem/Report	Possible Cause	Suggested Action
No Water Dispensing	Water supply turned off.	Check that power supply, and all taps/ valves/ filters on the incoming water supply are fitted and are turned on.
	"Leak detector" (if fitted) tripped off.	Disconnect the power and water supply, check for leaks. To reset the machine contact your distributor.
	Faulty water pressure regulator, or other failure.	Contact your distributor.
Warm Drinks	Insufficient cooling air flow through the fridge.	Contact your distributor.
	Faulty compressor, or other failure.	
Water lying on top edge of lower door panel and/or bottom of cabinet.	Overflowing drip tray waste container.	Empty waste container and check drainpipe is not blocked.
Water lying in bottom of machine.	Leak in pipe work and/ or filter.	Contact your distributor.
Bleeping Noise	Level sensor fitted and tank full.	Empty level sensor tank.

For full distributor
service manual visit:

www.borgandoverstrom.com/dealer/service-manuals

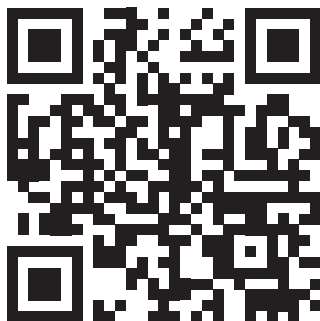

Customer services:
aftersales@borgandoverstrom.com
call +44 1362 695 006

Telephone
+44 (0)1362 695 006
Email
sales@borgandoverstrom.com

borgandoverstrom.com

© Copyright Borg & Overström.
This guide is printed by Borg & Overström and
shall not be reproduced or copied in anyway.

Ref: 838027
Version: B2.2.UG.v06082018