

T2/T2+ Tap systems

Dispense Options

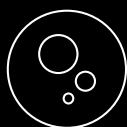

Chilled



Sparkling



Ambient

Contents

- Component/Feature Overview
- Operation
- Functions & Controls
- General Safety
- CO2 Bottle Installation
- Fault Finding

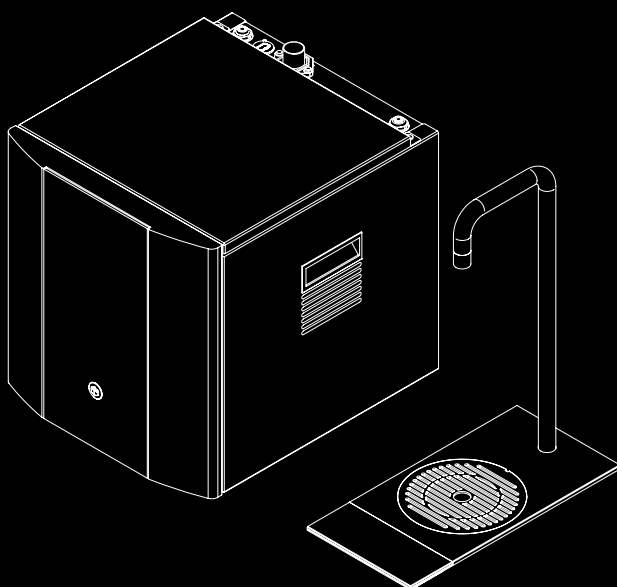

Safety

This appliance can be used by children aged from 8 years and above and persons with reduced physical, sensory or mental capabilities or lack of experience and knowledge if they have been given supervision or instruction concerning use of the appliance in a safe way and understand the hazards involved. Children shall not play with the appliance. Cleaning and user maintenance shall not be made by children without supervision

The unit should be isolated from the electricity supply before removal of any covers. Great care must be employed when working with high pressure carbon dioxide, and in no cases should the maximum operating pressure of 0.4MPa (4 bar) be exceeded.

- The appliance is not suitable for installation in an area where a water jet could be used.
- The appliance has to be placed in a horizontal position

WARNING: Keep ventilation openings in the appliance enclosure or in the built-in structure clear of obstruction.

WARNING: When positioning the appliance, ensure the supply cord is not trapped or damaged.

WARNING: Do not locate multiple portable socket-outlets or portable power supplies at the rear of the appliance.

This appliance is intended to be used in household and similar applications such as:-

- Staff kitchen areas in shops, offices and other working environments;
- Farm houses and by clients in hotels, motels and other residential type environments
- Bed and breakfast type environments;
- Catering and similar non-retail applications

A-weighted emission sound pressure level is below 70 dB(A)



R290

R290 is a refrigerant-grade propane used on a wide range of commercial refrigeration and air conditioning units. A highly pure propane, it has a low environmental impact and nominal global warming potential (GWP), meaning it possesses no qualities that can destroy the ozone layer. R290 also is the preferred hydrocarbon alternative of the Environmental Protection Agency (EPA), substituting more harmful fluorocarbon refrigerants like R22, R134a, R404a and R502.

Units with R290 can only be maintained and repaired by authorized technicians who are properly trained and certified.

Component/Feature Overview

T2 Tap

Contents:

- 1 no T2 Tap
- 1 no Top Plate with Control Panel
- 1 no Drip Tray
- 1 no 1.0m x 6mm Insulated Water Pipe
- 1 no Connector Cable
- 1 no Waste Drain Pipe
- 1 no Fixings Set

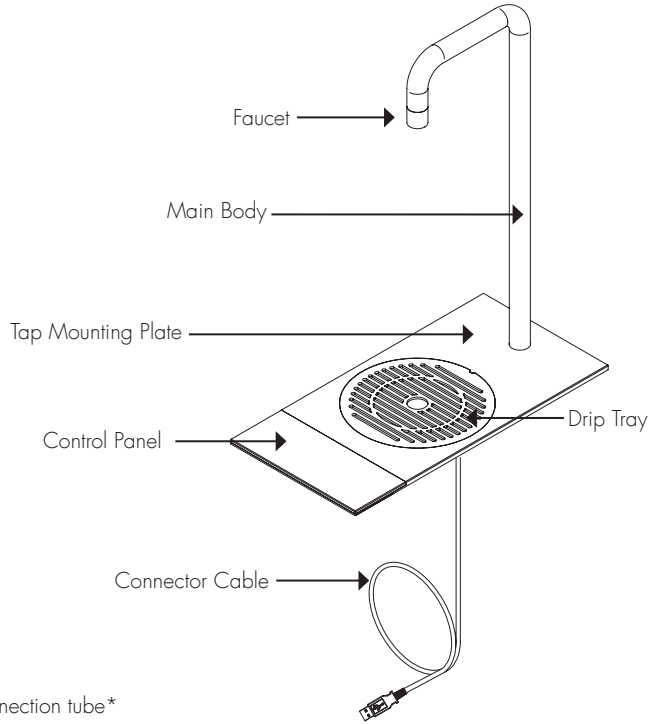

ProCore™ Undercounter

Contents:

- 1 no ProCore or ProCore+ Unit
- 1 no 2.0m Power Cord Set
- 1 no Co2 Regulator with Gauge & Connection tube*
- 1 no Ventilation Ducting Kit

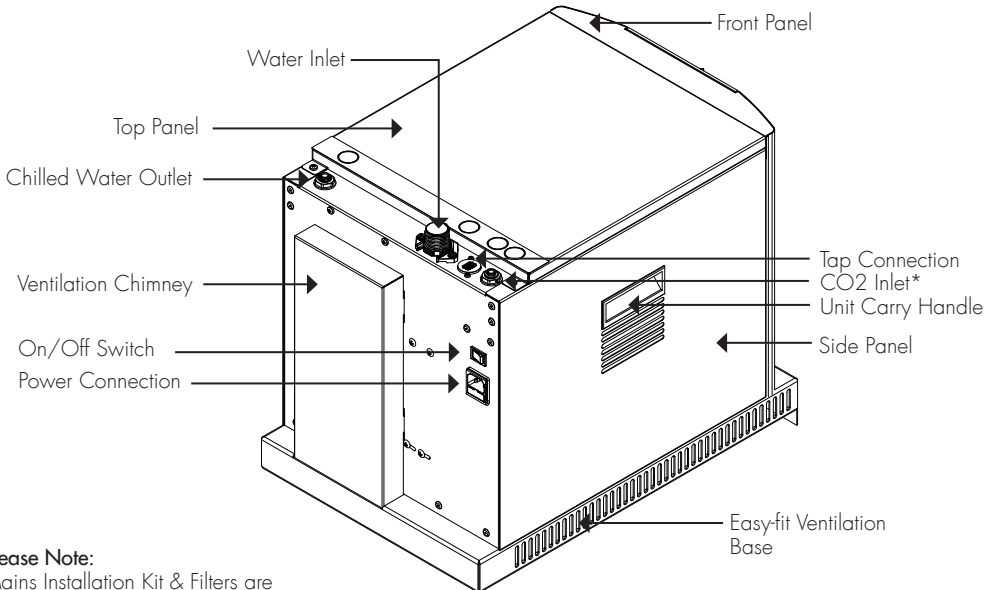

Please Note:

Mains Installation Kit & Filters are supplied as extra items according to individual ordering requirement.

*Sparkling versions only

Operation

Tap Control Panel

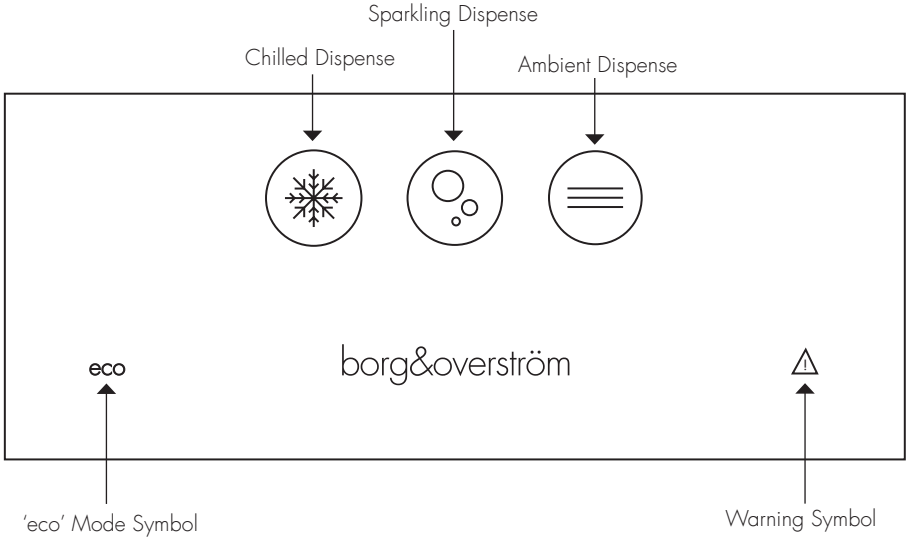

Basic Functions

Dispensing from unit:

Press and hold dispense icon and release to finish dispense

'eco' Mode:

'eco' mode symbol illuminates when unit is in 'eco' mode, to awaken unit press and hold any dispense icon. The Unit will activate 'eco' mode in the below instances

- Dispense inactivity
- Low room light level

Warning Symbol

'Warning triangle' symbol will illuminate and flash upon a fault. The number of flashes relates to a particular fault. Refer to the Instruction & Operation manual to diagnose.

Installation Requirements

- Identify a suitable location for the ProCore unit. It should be positioned within 1.0m of the faucet, and within 2.0m of suitable services connections. Allow enough space to fit the ventilation ducting system.
- The ProCore unit must be installed in accordance with the relevant requirements of:
 - The appropriate building regulations by application of either The Building Regulations (England and Wales), The Building Regulations (Scotland) or The Building Regulations (Northern Ireland). In territories other than those listed the local regulations in force must be complied with.
 - The Water Supply (Water Fittings) Regulations (England, Wales and Northern Ireland) or The Water Byelaws in Scotland.
- The unit must not be installed where it is liable to freeze. If the unit is thought to be frozen it must not be switched on. It should be allowed to thaw and must then be thoroughly inspected to ensure it is undamaged.
- Water: Mains potable water – internally regulated to 0.3MPa (3 bar)
- Minimum to maximum ambient room operating temperature: 5°C - 35°C
- CO2: Food Grade CO2 to be supplied
- Min mains pressure 0.05MPa (0.5 bar)
- Electricity: 5A supply – Earth Leakage Protected
- Waste Drain Connection

CO2 Bottle Installation - Sparkling Versions Only

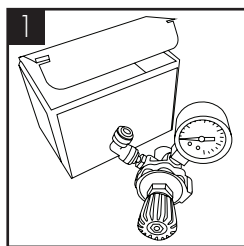

1
Unpack CO2 Regulator and fit elbow fitting to spigot outlet.

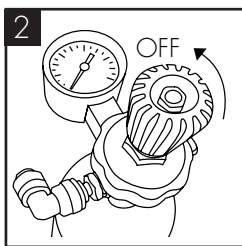

2
Attach the regulator to the CO2 bottle, ensuring the small pressure relief vent in the stem is facing away from you or anyone else. Ensure the regulator is closed. Hand tighten securely.

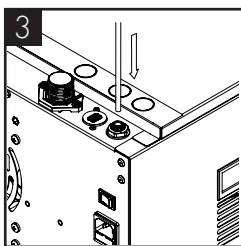

3
Connect the assembled CO2 bottle and regulator to the CO2 inlet using a 1/4" pipe.

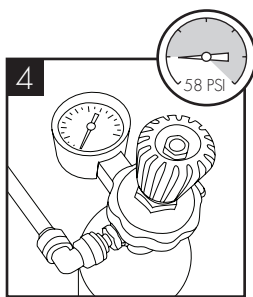

4
Stand the cylinder in a suitable place. We recommend between 3.5 - 4 bar (58 PSI) (max). Do not exceed 4 bar pressure.

Sanitisation Guide

To be completed by a technician or service provider

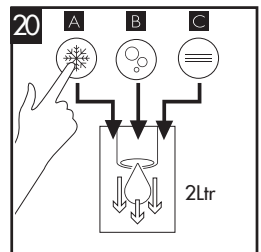
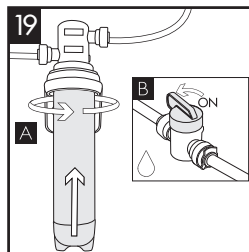
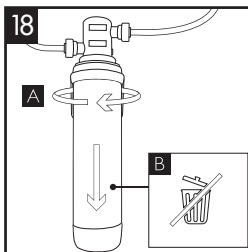
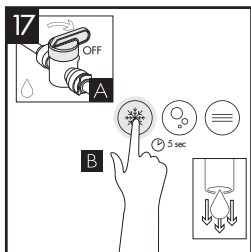
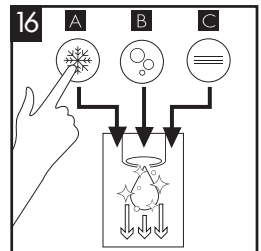
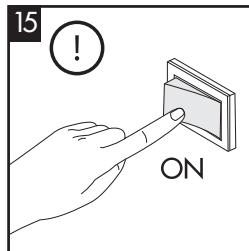
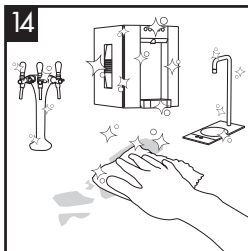
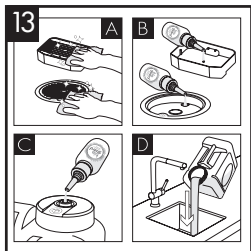
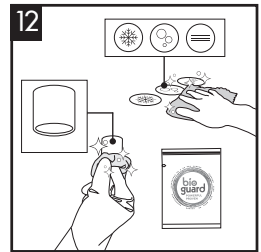
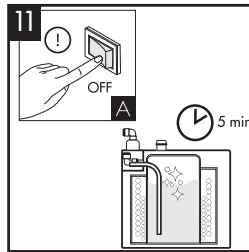
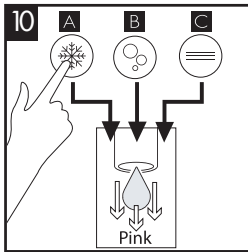
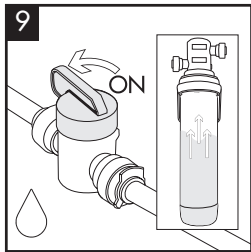
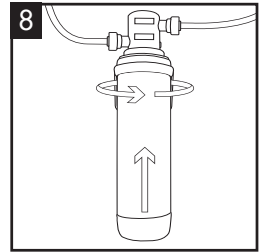
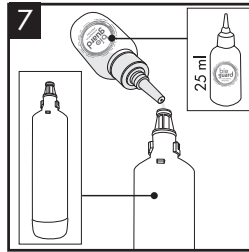
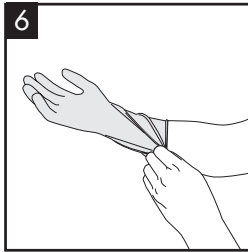
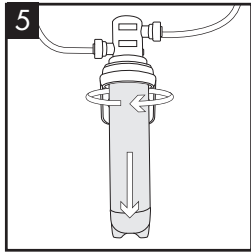
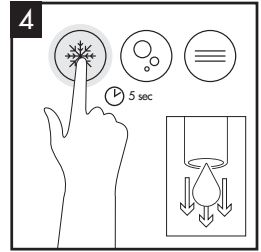
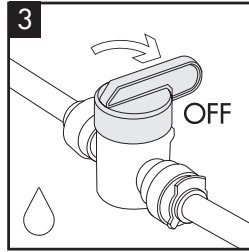
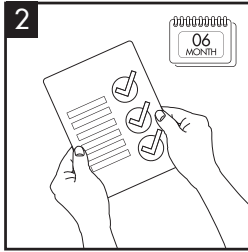
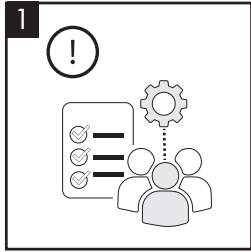

Waste Electrical Products:

- The WEEE symbol indicates that this item contains electronic components which must be collected and disposed of separately.
- Never dispose of electrical waste in general municipal waste. Collect and dispose of such waste separately.
- Make use of the return and collection systems available to you, or your local recycling programme. Contact your local authority or place of purchase to find out what schemes are available.
- Electrical and electronic equipment contains hazardous substances which, when disposed of incorrectly, may leak into the ground. This can contribute to soil and water pollution which is hazardous to human health; and endangers wildlife.
- It is essential that consumers look to re-use or recycle electrical or electronic waste to avoid it going to landfill sites or incineration without treatment.



Basic Troubleshooting

Problem/Report	Possible Cause	Suggested Action
No Water Dispensing	Water Pressure Regulator	Contact your distributor
No Sparkling Water - If applicable	No CO2 pressure	Check CO2 bottle, regulator and non- return valve. Supply pressure should be 58 psi (3.5-4bar), replace as necessary
	Carbonator Tank Not Filling	Contact your distributor
Poor Quality Carbonation - If applicable	Air in Carbonator Tank	Isolate the power supply and operate the sparkling water tap until gas is expelled. Allow gas to expel for 5 seconds. Switch on power supply and allow the tank to refill
	Residue in Carbonator Tank	After prolonged use, a surface film can develop within the carbonator tank. Refer to cleaning and sanitising instructions
	Carbonator Tank is Overfilled	If pump runs continuously, contact your distributor
Warm Drinks	Insufficient cooling air flow through the fridge	Check that the ventilation kit has been installed correctly.
	Compressor not running	Contact your distributor
	PCB not operating	
	Fridge failure	

General Safety

- Always place the dispenser in its vertical position, on a surface which can capably support its weight.
- During use this machine must remain in its upright position.
- Adequate ventilation must be allowed for - we recommend using the supplied ventilation ducting kit.
- Keep the machine away from sunlight, heat and moisture.
- The environment where this machine is installed must be free of dust and corrosive/explosive gases.

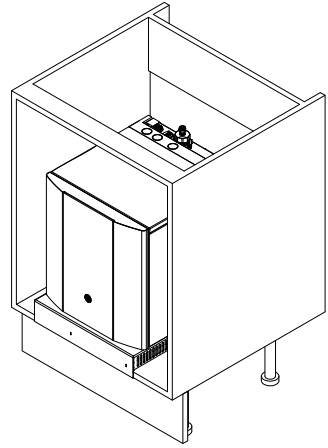

For full distributor
service manual visit:

www.borgandoverstrom.com/manual/t2

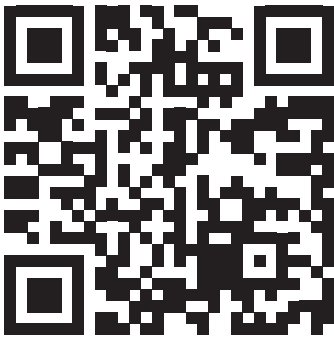

Customer services:
aftersales@borgandoverstrom.com
call +44 1362 695 006